



Video Processor User Manual

Product ranges covered by this manual

Vi-P14 Vi-P14A	Vi-Q4C1
	

Document Reference

Viq601a.doc

Date

26/11/2009

Firmware

From Viq001a21

Videoswitch

Ocean House, Redfields Industrial Park
Redfields Lane, Church Crookham
Hants GU52 0RD

Telephone 01252-851510

Fax 01252-851296

Email sales@videoswitch.co.uk

Web www.videoswitch.co.uk

Contents:

1	Start Here	1
1.1	Connecting Up	2
1.2	Keypad	2
2	Front Panel.....	4
2.1	Leds	4
3	Menus	5
3.1	Login	6
3.2	System	6
3.2.1	Datetime.....	6
3.2.1.1	Enter Datetime	6
3.2.1.2	Daylight Saving	6
3.2.1.3	Show Datetime	6
3.2.2	Vga Mode.....	6
3.2.3	Language	6
3.2.4	Restore Factory Defaults	6
3.3	Display	7
3.3.1	Format.....	7
3.3.2	Image Positions	7
3.3.3	Title Positions.....	7
3.3.4	Selectable Formats	8
3.3.5	Text Background.....	8
3.3.6	Image Borders	8
3.3.7	Titles	8
3.3.7.1	Unit Title	8
3.3.7.2	Camera1 Title.....	9
3.3.7.3	Camera2 Title.....	9
3.3.7.4	Camera3 Title.....	9
3.3.7.5	Camera4 Title.....	9
3.4	ALARMS	9
3.4.1	Pull Up	9
3.4.2	Relay Time	9
3.4.3	Video Loss Mask.....	9
3.5	CONFIG	10
3.5.1	Lock Keypad	10
3.5.2	Termination	10
3.5.3	Password	10
3.5.4	Transmit Config.....	10
3.5.5	Restore Factory Settings	10
4	Connections.....	11
5	Technical Data	12
5.1.1	Remote Keyboard (lower connector)	12
5.1.2	Alarms (upper connector)	12
5.2	Specifications.....	13
5.2.1	Vi-P14 Screen Modes	13
5.2.2	Vi-P14A Additional Screen Modes.....	13
5.2.3	Vi-Q4C1 Screen Modes	13
5.2.4	Video Processing	13
5.2.5	Display	14
5.2.6	Control and Interface	14
5.2.7	Power, Physical & Environmental	14
5.2.8	Upgrades	14

5.2.9	CE Marking	16
5.2.10	Ventilation	16
5.2.11	Safety	16

1 Start Here

- The Vi-P14, Vi-P14A and Vi-Q4C1 are quad video processors
- These products accept analogue video inputs from up to four cameras or other video sources
- Each video input can be scaled, cropped, mirrored, positioned and then combined on the analogue video output
- A VGA output is provided on the Vi-P14 and Vi-P14A for driving any VGA enabled monitor or TV
- Menus allow the user to configure the unit
- Configuration may also be uploaded and downloaded using a PC
- The Vi-P14A and the Vi-Q4C1 have fully user-programmable screen formats
- The Vi-Q4C1 has additional features aimed at transport applications, including video presence status LEDs, video loss alarming, special screen formats for platform monitoring and additional status monitoring software for high reliability operation in critical applications.
- Alarm inputs are provided that may be used for full screen pull-up
- Software updates may be installed via RS485 from a PC running Vi-SA1 Configuration Manager.

Note:

This manual covers a range of products and therefore describes features that do not exist in all models.

1.1 Connecting Up

For a standard digital recording system you will need

- The Vi-P14, Vi-P14A or Vi-Q4C1 Video Processor
- Some cameras with lenses
- A video monitor (with BNC composite video input) or a VGA monitor
- BNC cables

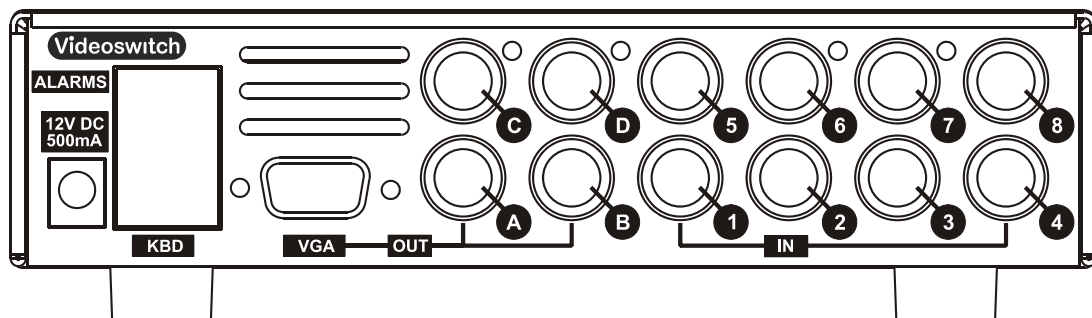







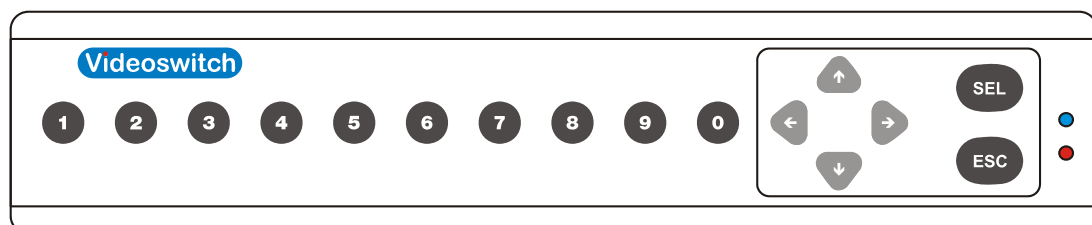

- Connect the monitor output (MAIN) of the Video Processor to a Video Monitor using a BNC cable
- Make sure that the monitor termination is switched on (i.e. to 75 Ohms)
- Connect a camera to Camera Input 1 on the Video Processor using a BNC cable
- Connect further cameras to Inputs 2,3,4 etc
- Connect the mains power using the mains cable provided

1.2 Keypad

The Vi-P14 and Vi-P14A have a mini-keypad with the key layout as above. All functions can be controlled by the 16 keys provided. Two additional functions are provided by holding down the SEL key for 1 second or the ESC key for 1 second.



Names of keys used in this manual	Keypad legend	Used for
number		Select cameras and enter numbers when in the menu
right		Select next screen format, navigate in menu
left		Select prior screen format, navigate in menu
up		Select next input for spot monitor, navigate in menu
down		Select prior input for spot monitor, navigate in menu
SEL		Enter menu or select or confirm within the menu
ESC		Escape from current menu level to prior level
DEFAULT	 Hold for 1 second	Set a menu setting to default value
EXIT	 Hold for 1 second	Exit from menu

2 Front Panel

The Vi-Q4C1 has a front panel with LEDs to indicate important status information. Note that this model requires a PC or Vi-K1 Remote Keyboard to access the menus or change screen modes.

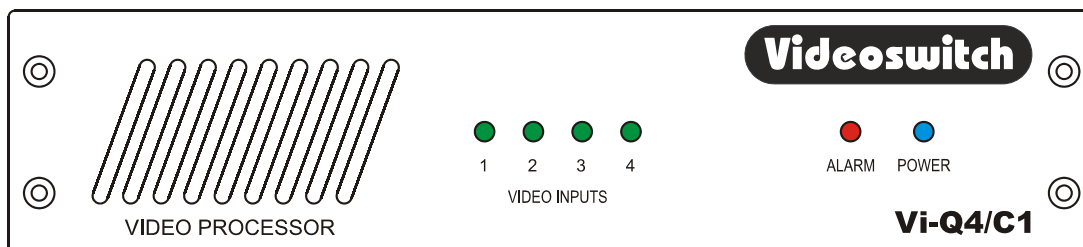









2.1 Leds

Video Inputs 1,2,3,4	The green video input LEDs illuminate when video is present on the corresponding camera inputs
Alarm	The red alarm LED illuminates when an alarm condition is detected. Alarm conditions include video loss, external alarms and system malfunction
Power	The power LED indicates that DC power is being supplied to the unit

3 Menus

- The menu system in this Video Processor allows many aspects of its operation to be customised to suit a specific installation
- Note that not all menu options described below are available on some models
- The factory defaults may be restored at any time via the **CONFIGURATION** menu

The keys listed below refer to the built-in keypad. If you are configuring using the Vi-SA1 Configuration Manager software, the keys are the same except dedicated **DEFAULT** and **EXIT** keys are provided.

Key name	Key legend	Action
SEL		Enter the menu system. Select an item for editing and also confirm changes
Up		Select the prior menu item or scroll a value when editing
Down		Select the next menu item or scroll a value when editing
Right		Go a level deeper into the menu or move cursor when editing
Left		Come out of a level in the menu or move cursor when editing
DEFAULT	Press and hold for 1 second 	Set the default setting of a menu item
ESC		Escape from a menu level or escape from editing a value without saving
EXIT	Press and hold for 1 second 	Leave menu completely. Any changes will be saved.

3.1 Login

Some parts of the menu are password protected. Enter the password here to gain access to the menu.

- Use **left** and **right** to move the cursor
- Use **up** and **down** to select the digits
- Use **left** or **ESC** to exit this menu item

A message on the screen will indicate if you have logged in successfully. A timer keeps you logged in while you are pressing keys. After a period of inactivity, you will be logged out. You may manually log out by changing the password to an invalid value (e.g. all zeros). The default password is: 111100.

3.2 System

3.2.1 Datetime

3.2.1.1 Enter Datetime

Press **SEL** to start editing the date and time.

Enter the current date and time using the **number** keys.

Use the **left** and **right** keys to move between the digits as required if you do not want to re-enter the whole date and time.

The date/time format is DD/MM/YY HH:MM:SS.

Press **SEL** when you have finished editing the date and time, or press **ESC** to cancel.

Battery backup ensures that the clock continues working even when power is removed for short periods of time

3.2.1.2 Daylight Saving

If you select the daylight saving option, the clock automatically moves forwards an hour during March and back an hour in October for daylight saving. No adjustment by the user is required when the clocks change. The times and dates suit most European countries.

3.2.1.3 Show Datetime

This option determines whether the date and time is displayed on the screen.

3.2.2 Vga Mode

This menu item allows the VGA output format to be set to suit the connected VGA monitor. Choose the resolution to get the best results from the connected VGA monitor.

3.2.3 Language

Select from available languages using this option.

3.2.4 Restore Factory Defaults

If you wish to restore all screen formats and other settings to the factory defaults, select **Yes** in this menu option.

3.3 Display

3.3.1 Format

Prior to editing image positions or title positions, select the screen format that you wish to edit.

3.3.2 Image Positions

- Use the **number** keys 1, 2, 3 and 4 to select the camera for which you wish to adjust the image position.
- Use the **up** and **down** keys to select which field you wish to edit
- Use the **left** and **right** keys to edit the number in the selected fields
- Use **DEFAULT** to restore the factory defaults of the selected screen format
- Repeat for other cameras
- Press **ESC** to exit this screen back to the menu

The image parameters that can be adjusted are:

Field	X range	Y range	Comments
Visible	YES or NO		Determines whether the camera image is displayed
Top Left	0 to 176	0 to 142	Position of the top-left corner of the displayed camera image
Bottom Right	0 to 176	0 to 142	Position of the bottom-right corner of the displayed camera image
Scale	0 to 255	0 to 255	The scale of the displayed image relative to the input image (255 represents 1:1)
Offset	0 to 176	0 to 142	The position in the input image that becomes the top-left of the display image.
Mirror	YES or NO	YES or NO	Set to YES if you want the image to be mirrored horizontally, vertically or both.

Note:

- The coordinate X=0, Y=0 represents the top-left of the image.
- X-coordinates refer to the horizontal, larger numbers being further to the right
- Y-coordinates refer to the vertical, larger numbers being further to the bottom

3.3.3 Title Positions

- Use the **number** keys 1, 2, 3 and 4 to select the camera for which you wish to adjust the image position.

- Use the number keys **9** and **0** to select the **Date/Time** and **Unit title**
- Use the **up**, **down**, **left** and **right** keys to move the selected title to the desired location on the screen.
- Note that the **down** key moves the title down by 8 steps whilst **up** moves it up by just 1 step. This arrangement allows fine control of the vertical position without requiring too many key presses.
- Use **DEFAULT** to restore the factory defaults of the selected screen format
- Repeat for other cameras
- Press **ESC** to exit this screen back to the menu

Field	X range	Y range
Camera Title	0 to 57	0 to 144
Unit Title	0 to 57	0 to 144
Date/Time	0 to 57	0 to 144

- The coordinate X=0, Y=0 represents the top-left of the image.
- X-coordinates refer to the horizontal, larger numbers being further to the right
- Y-coordinates refer to the vertical, larger numbers being further to the bottom

3.3.4 Selectable Formats

Screen formats may be selected from the keypad by pressing the **number** keys or the **left** and **right** keys. This menu option allows you to specify which formats you want to be able to select.

- Use left and right to move choose the format
- Use up and down to specify whether you want the format to be selectable from the keypad or not. A solid block indicates a format can be selected whereas a dash indicates that it cannot.

3.3.5 Text Background

You can choose whether the text is surrounded by a solid block of black or blue background colour or just a thin border (to ensure the text can be ready whatever the colour of the video image).

3.3.6 Image Borders

Each camera image may be surrounded by a black or white border, or no border.

3.3.7 Titles

3.3.7.1 Unit Title

The Video Processor may be given a unit title that is displayed on the screen at all times.

- Use **left** and **right** to move the cursor
- Use **up** and **down** to select the character

- Use **DEFAULT** to default or clear the title

3.3.7.2 Camera1 Title

Each camera may be given a title that is displayed on the screen whenever that camera image is displayed.

- Use **left** and **right** to move the cursor
- Use **up** and **down** to select the character
- Use **DEFAULT** to default or clear the title

3.3.7.3 Camera2 Title

See above

3.3.7.4 Camera3 Title

See above

3.3.7.5 Camera4 Title

See above

3.4 ALARMS

3.4.1 Pull Up

This setting determines whether an alarm input 1, 2, 3 or 4 will cause formats 1, 2, 3 or 4 respectively to be called up.

3.4.2 Relay Time

When an alarm occurs the relay operates. This option specifies for how the relays remains active after the alarm condition has ceased.

3.4.3 Video Loss Mask

This mask determines which input are monitored for video loss.

- Use **left** and **right** to move the cursor
- Use **up** and **down** to select whether the input is to be monitored for video loss. A solid block indicates that monitoring is **ON**. A dash indicates that monitoring is **OFF**.
- Use **DEFAULT** to default the monitoring settings to all on or all off.

3.5 CONFIG

3.5.1 Lock Keypad

If you do not want the user to be able to select screen formats or cameras, set this option to **YES**. To change screen format you now have to enter menu, enter password and change the screen format in the **Format** menu.

3.5.2 Termination

Select here whether you want each camera input to be terminated with 75 Ohms. The default is termination ON.

- Use **left** and **right** to move the cursor
- Use **up** and **down** to select termination. A solid block indicates that termination is **ON** (75 Ohms). A dash indicates that termination is **OFF** (high impedance)
- Use **DEFAULT** to default the termination settings to all **ON**.

3.5.3 Password

The default password (111100) may be changed in this menu.

3.5.4 Transmit Config

This menu option allows the whole menu configuration to be transmitted via the RS485 output. If you are using the Vi-SA1 configuration manager software, it is not necessary to use this option as the software requests the configuration automatically.

3.5.5 Restore Factory Settings

Set this option to Yes if you want to default all settings including screen formats to the factory defaults.

4 Connections

This shows a typical example of the video and power connections required. The spot monitor is optional. The second row of BNC connectors may be used for loop-through.

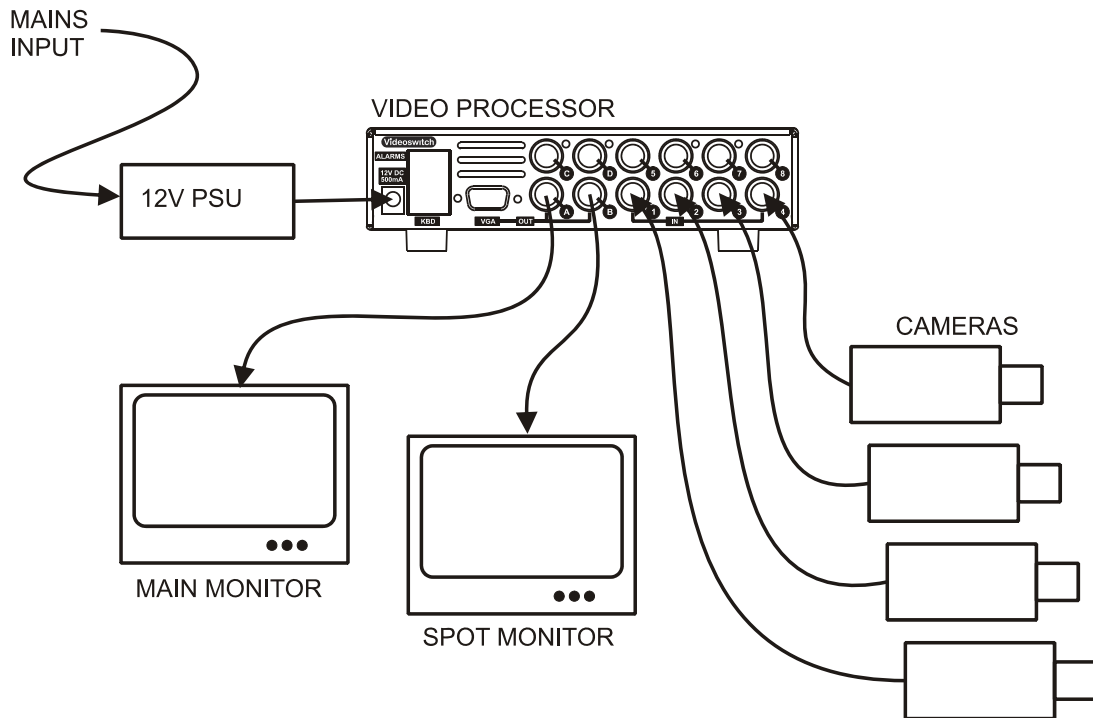

5 Technical Data

5.1.1 Remote Keyboard (lower connector)

Physical: RJ45
 Electrical: RS485

Pin Number	Signal
1	RS485 Input+ (A)
2	RS485 Input- (B)
3	RS485 Output+ (A)
4	+9V output for Keyboard
5	GND
6	RS485 Output- (B)
7	Not used
8	Not used

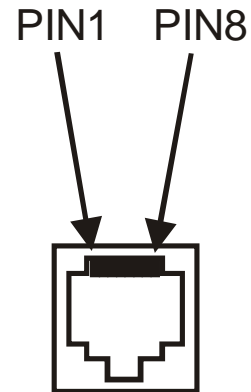

5.1.2 Alarms (upper connector)

Physical: RJ45
 Electrical: RS485

Pin Number	Signal
1	Alarm Input 1
2	Alarm Input 2
3	Alarm Input 3
4	Alarm Input 4
5	GND
6	Relay COM
7	Relay N/O
8	Relay N/C

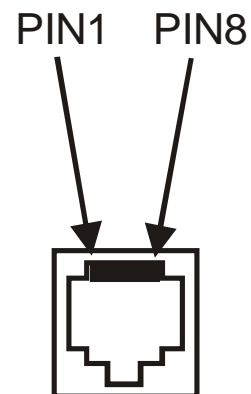

5.2 Specifications

5.2.1 Vi-P14 Screen Modes

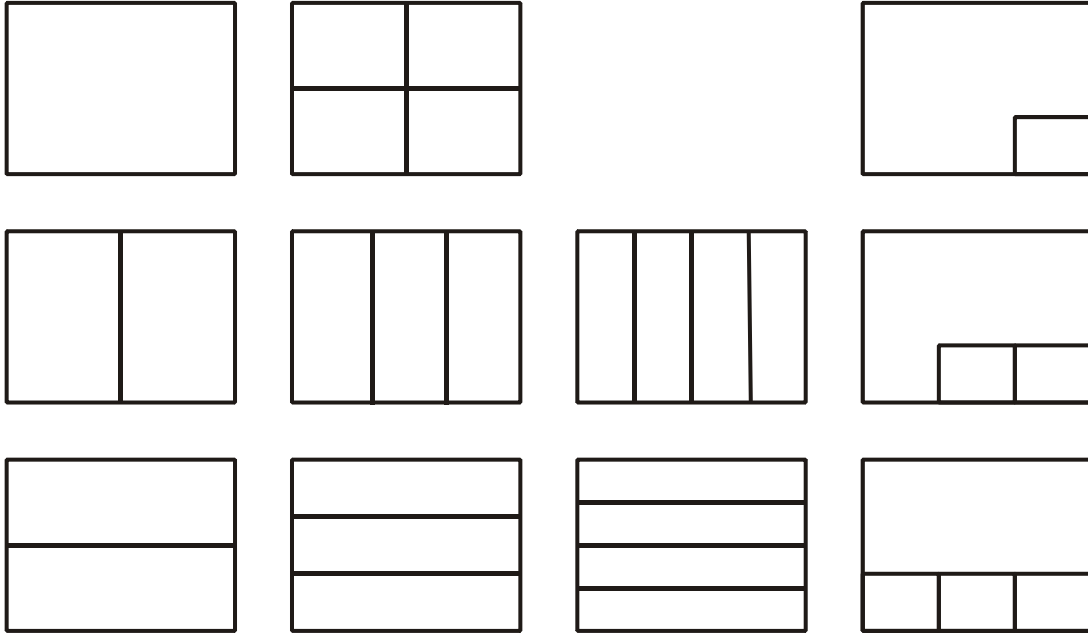

The vertical and horizontal splits provide both cropped and squished options.

5.2.2 Vi-P14A Additional Screen Modes

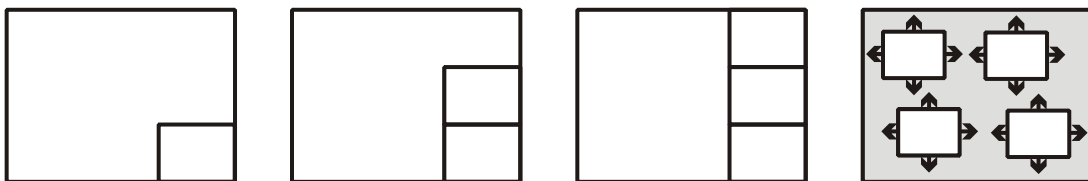

All screen modes are fully programmable and may be edited by the user via the keypad or using the Vi-SA1 Configuration Manager software.

5.2.3 Vi-Q4C1 Screen Modes

All screen modes are fully programmable and may be edited by the user via the keypad or using the Vi-SA1 Configuration Manager software. Default screen modes are customised to user requirements.

5.2.4 Video Processing

Camera inputs	4
Video format	PAL
Colour/Monochrome	Auto sense
Gain, Brightness, Colour	Auto

Resolution	720 x 576 pixels x 16.8 million colours
Hardware/Software	Embedded processor, proprietary Videoswitch software
Simultaneous processing	Scaling, cropping, pan,
Video inputs	0.5 to 1V pk-pk, 75 Ohms (switch able via menu), composite PAL (BNC), all inputs have loop-through BNCs
Loop-Through	On BNC video inputs and outputs

5.2.5 Display

Main monitor output	(a) Composite (BNC), 1V pk-pk composite PAL (b) VGA monitor output
Spot monitor outputs	BNC, 1V pk-pk composite PAL
Main monitor display modes	Full screen, quad, 2-way, 3-way and 4-way vertical and horizontal split with crop or squish. 2-way and 3-way picture in picture (PIP). Optional horizontal and/or vertical mirroring.
Titles	16 character titles for each camera and for unit, may be displayed anywhere on screen
Date and Time	May be displayed anywhere on screen

5.2.6 Control and Interface

Keypad (not Vi-Q4C1)	16 single keys
Remote keyboard Inputs	RJ45, RS485, 9600-baud (1 start, 8 data, 1 stop) data
Passwords	Protects menu and optionally keypad control
Alarm inputs	4 inputs, suit normally open volt-free contacts
Relays	Change-over contacts operate on alarm
Relay Contact Rating:	24Vdc, 200mA max normally open or closed
Alarm/activity response	Pull-up full screen formats 1, 2, 3, and 4
Watchdog timer	In the event of any unexpected condition, the system will automatically restart
Status LEDs (Vi-Q4C1)	Video inputs (x4) Green video presence LEDs Alarm Red alarm warning LED Power Blue 12V power LED

5.2.7 Power, Physical & Environmental

Mains Power input	90-135 Vac 0.5 Amps or 180-265 Vac 0.25 Amp, 47-63Hz
Temperature	5 to 35deg C (operating), -10 to 40deg C (storage)
Humidity	5 to 95% non-condensing
Dimensions/Weight (Unit)	180mm x 44mm x 200mm (WxHxD), 3kg
Dimensions/Weight (Boxed)	275mm x 380mm x 475mm (WxHxD), 5kg

5.2.8 Upgrades



Video Processor

Firmware upgrades

Firmware upgrades will be made available on the Internet
(free of charge)

5.2.9 CE Marking

This product is CE marked. It has been fully tested and complies with 89/336/EEC Electromagnetic Compatibility and 73/23/EEC Low Voltage directives, and with EN 60950:2000 safety standards.

Warning: This is a Class A product. In a domestic environment this product may cause radio interference in which case the user may be required to take adequate measures.

5.2.10 Ventilation

The Video Processor has ventilation holes in the base and rear. The ventilation holes must not be obstructed otherwise the lifetime and reliability of the system may be affected.

5.2.11 Safety

For warranty and safety reasons, the cover of this equipment must not be removed. There are no user serviceable parts inside.



Video Processor

Serial Number of Video Processor

Notes

